



1. Introduction to equestrian access

Horse-riding is an increasingly popular sport and leisure activity. British Horse Society (BHS) surveys suggest that horse numbers in Scotland have increased by 45% over the last 10 years to a current figure of approximately 100,000. Samples of riding schools also report annual increase in demand. Providing for horses and their riders is therefore increasingly important, particularly in the light of the Land Reform (Scotland) Act 2003. Yet many people involved in development and delivery of public access feel that they lack the required knowledge or confidence to deal with equestrian access.

These factsheets have been produced by British Horse Society Scotland (BHSS) in partnership with Scottish Natural Heritage (SNH) and Paths for All Partnership (PFAP), for everyone with an interest in or responsibility for developing or managing equestrian access, whether professionally or voluntarily. The factsheets provide a readily accessible summary of key practical points about providing access for horses and riders. They are intended to complement and provide pointers to other relevant sources of information. In particular, the factsheets should be read in conjunction with the Lowland Path Construction Guide. For ease of reference, brief details of the most commonly used path construction techniques, bridlegates and a simple bridge suitable for horses are included. The level of technical detail reflects availability of information elsewhere, and relative significance of the information.

Riders are no different to walkers, cyclists or anyone else who enjoys the countryside: they (and their mounts) come in all shapes and sizes, and vary considerably in their interests, needs and preferences. Some prefer well defined, surfaced routes whereas others prefer the challenge of informal, ill-defined paths across remote hills. The key wherever possible is to provide a variety of routes, surfaces and experiences, and to take into account basic needs, aspirations and constraints of all users.

Key considerations in providing access for horse-riders

- Safety of horse and rider – and of others enjoying countryside access - is the over-riding consideration.
- On promoted horse routes, riders expect to be able to enjoy readily passable and unobstructed clearly signed paths without any sections on busy or dangerous roads or across potentially dangerous boggy ground, offering a variety of conditions, views and experiences.
- Minimum height of a mounted rider is 2.55m above ground level. Overhanging branches and any other obstructions should be cleared to minimum 3m (preferably 3.7m) on all riding routes.
- Adequate turning space and safe loading/unloading areas are essential where parking is provided for horse boxes/trailers.



1. Introduction to equestrian access

Path Planning

Exactly the same principles apply to planning paths for horse-riders as for any other users. Factors to be taken into consideration include the type, level and seasonality of existing and potential use(s), drainage, accessibility (particularly important in terms of surfacing), practical farm/land management issues, future maintenance implications and available resources.

Creating and maintaining dedicated paths solely for horse-riders is an expensive luxury few can afford, and in most cases will not be justifiable under the Land Reform Act. Not all paths will be suitable for multi-use, but there are countless examples throughout Britain of paths successfully supporting walkers, cyclists and riders simultaneously. The needs of all users of different ages and abilities, existing and potential, should be taken into consideration. Provided paths are able to support equestrian use without undue damage, stiles or restrictive access controls which present a barrier to equestrian use should be replaced, which will often also help increase accessibility to other users.

Understanding horses

The average weight of a horse is 500kg, and average size of a horse's hoof varies from 110mm to 250mm diameter. Depending on pace, only two hooves may be in ground contact simultaneously, hence a considerable weight is concentrated on a very small area. The greatest risks for horses are getting stuck in boggy ground and holes in which they may strain or break a leg. Either may have fatal consequences.

Tips on path planning

- Successful paths are those which are "fit for purpose", i.e. designed and managed according to level and type of use, location and land management considerations.
- Paths should facilitate access by as wide a range of users as sustainably possible.
- Paths should not be developed for one type of user at the cost of another.
- Particular care is required to ensure that development of paths for equestrian access does not adversely affect disabled users. The Disability Discrimination Act (1995) makes it unlawful for access providers to treat disabled people less favourably than they would treat others, for a reason related to their disability. Further information on DDA is included in the Countryside Access Design Guide Appendix 2.
- Consultation with existing and potential users, as well as landowners and managers, is essential to ensure paths work for everyone (see Section 2 of Lowland Path Construction Guide).

There is no substitute for first-hand experience – by far the best way of appreciating how difficult gates can prove to negotiate on horseback, or of testing out acceptable gradients or surfacing, is to try for yourself from the saddle. Local riding schools, horse access groups or BHS volunteers will usually willingly arrange for those involved in access to get on a horse and experience for themselves the thrills and frustrations of equestrian access. Remember that local riders and horse-owners will often be willing to help plan and implement routes.



1. Introduction to equestrian access

Path surfacing from a horse's perspective

A simple knowledge of the anatomy of the horse's foot and legs provides great insight into the implications of path surfacing. The horse's foot comprises an insensitive outer layer of horny tissue, which surrounds and protects sensitive inner structures. Most horses in regular work are shod with metal shoes, which are designed to protect the hoof wall (the main bearing surface) from excessive wear, and to evenly spread the load of horse and rider around the hoof wall.

Structure of the horse's hoof

Cross section through hoof showing sensitive and insensitive areas

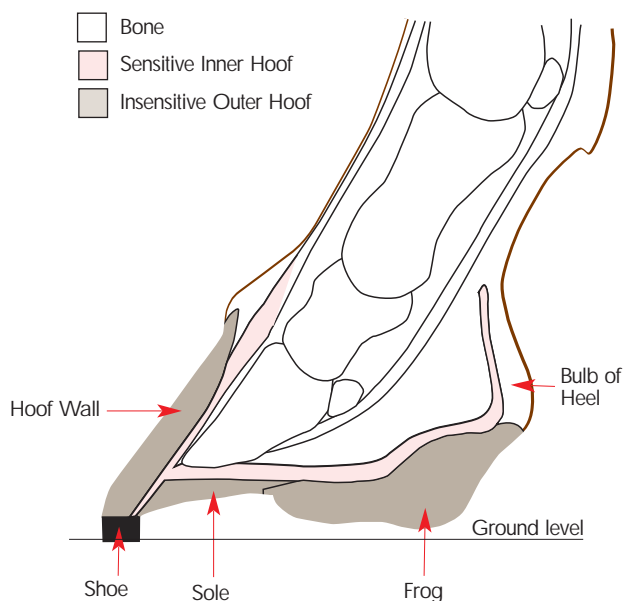

The unshod surface of the remainder of the hoof comprises the sole, which covers and protects the solar surface of the pedal bone and sensitive laminae of which the hoof is formed, and the central "frog", which helps

absorb concussion and pump blood through the hoof. The sole is derived from the very sensitive membrane which covers the pedal bone, and hence although it may appear relatively hard, it is in fact relatively thin and easily bruised. The sole of the hoof is naturally arched so that on flat, compacted surfaces, the sole will not come into contact with the path and hence there is minimal risk of bruising. However, on unconsolidated stone surfaces, sharp edges of stones may protrude into and bruise the sole of the foot, causing lameness. Similarly loose stones may also become wedged in the hoof, exerting painful pressure on the underlying tissues each time the horse bears weight on the hoof until the stone is removed. Even regularly shaped smaller stones, such as pea gravel, are uncomfortable for soft-soled horses. Infection within the hoof resulting from stone punctures to the sole can cause serious problems. Resultant swelling constrained within the horny hoof wall exacerbates the pain from bruising or puncture hoof injury.

Underside of the hoof

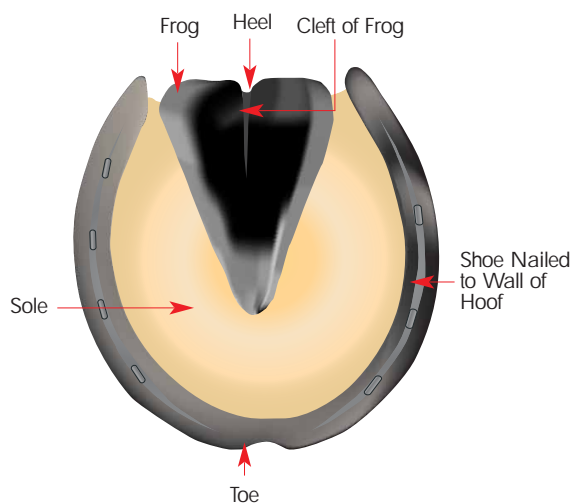



1. Introduction to equestrian access

The level of concussion to both the hoof and horses' legs increases with the hardness of the surface, and with the speed at which the horse is moving. Trotting or cantering on tarmac or hard tracks will soon lame a horse by placing strain on the legs, potentially resulting in permanent impairment. Grass tracks which provide ideal fast going for much of the year can bake sufficiently hard to restrict horses to a walk in very dry weather.

Cross section through hoof showing potential pressure and damage from sharp stones

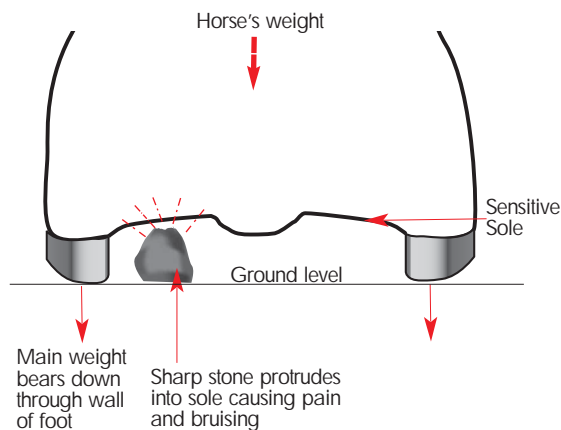

Path surfacing from a rider's perspective

Path priorities from a horse-rider's perspective are:

- A surface which is safe i.e. relatively non-slip and with a firm base (which may only be subsoil) so that there is no risk of the horse sinking.
- A comfortable surface for the horse to move across without risk of bruising the sole of the hooves.
- Paths offering scope for a range of pace. Inexperienced riders or unfit horses may be happy walking all the way, but most riders look for opportunity to trot, canter and occasionally gallop. Hard surfacing of multi-use paths to improve the surface for other users or to restrict pace of horses for safety or other reasons will usually prompt riders to look for alternative paths in the vicinity for faster riding. The fewer the opportunities, the more use will be concentrated on those paths which are available.



1. Introduction to equestrian access

Gradient

BHS suggest the ideal maximum gradient for ridden use is 1:12, but obviously needs and preferences vary considerably. Some riders welcome the challenge of particularly steep ascents or descents. Tracks with long inclines are useful for building stamina, but less able riders and very young or old horses may struggle to maintain balance on steep paths, particularly where the surface is loose or where there is poor grip. Steep descents generally put much more strain on horses' legs (and riders' knees) than steep ascents. Sufficient space to get a run up a slope, or to come to a halt at the bottom is important, as is semi-level ground at the top of a steep slope on which to regain balance and breath.

Vegetation, surfacing, level of use, types of user and risk of erosion are likely to be more restrictive on gradient than ability of horse and rider. The Pennine Bridleway has adopted a standard of 8 degrees maximum gradient (i.e. 1 in 7) beyond which sweeping "S" bends are incorporated in the path.

Width

Acceptable width depends on level and type of use, gradient, ground conditions and surface. BHS recommend the ideal bridleway as 5-6m wide, but many paths used by horses are at most 1m wide. The narrower a riding route, the more wear and tear will be concentrated, and the less space for walkers, cyclists and horses to pass safely and comfortably. Encroaching vegetation can be as significant as poor drainage or surfacing in reducing usable width. Narrow paths are a particular problem for horses adjacent to electric or barbed wire fences, where paths follow the contour on a steep gradient, and/or where there is a sharp drop to the side.

Key considerations for horses re. path width

- Aim for a minimum of 2-3m finished width but accept that narrower sections are inevitable and still quite rideable (minimum 0.5m).
- Match width to ground conditions, level and type of use.
- On narrow and multi-use paths, provide adequate passing points.
- Take account of visual impact of paths – the wider the path, the more visually obtrusive it is likely to be.



1. Introduction to equestrian access

Useful references

BT Countryside for All: Standards and Guidelines. A Good Practice Guide to Disabled People's Access in the Countryside (BT Community Partnership and Fieldfare Trust). Available from The Fieldfare Trust, 67a The Wicker, Sheffield, South Yorkshire S3 8HT.

Countryside Access Design Guide (Scottish Natural Heritage) includes guidance on a range of structures such as gates frequently used to assist and manage public access to the countryside. Available from Scottish Natural Heritage Publications Section, Battleby, Redgorton, Perth PH1 3EW tel. 01738 444177

Lowland Path Construction – A Guide to Good Practice (Scottish Natural Heritage, Scottish Enterprise, Paths for All Partnership) available from Paths for All Partnership, Inglewood House, Tullibody Road, Alloa FK10 2HU tel. 01259 218888

Upland Path Management - Standards for delivering path projects in Scotland's mountains (Upland Path Advisory Group) contains a wealth of invaluable information and advice on path assessment, planning, delivery and health and safety. Although primarily focused on footpaths, the general principles are equally relevant to equestrian and multi-use paths. Available from Scottish Natural Heritage Publications Section, Battleby, Redgorton, Perth PH1 3EW tel. 01738 444177

Upland Pathwork – Construction standards for Scotland (Upland Path Advisory Group) available from Scottish Natural Heritage Publications Section, Battleby, Redgorton, Perth PH1 3EW tel. 01738 444177 (in course of reprint)

A Guide to the surfacing of Bridleways and Horse Tracks (British Horse Society) available from British Horse Society Access and Rights of Way Department, Stoneleigh Park, Kenilworth, Warwickshire CV8 2LR tel. 01926 707700 / 08071 202244

Further information and advice
British Horse Society Scotland Access Officer, Pat Somerville, The Loaning, Auchengate, Irvine KA11 5BH tel: 01294 270891

British Horse Society, Stoneleigh Deer Park, Kenilworth, Warwickshire CV8 2XZ tel. 08071 202244/ 01926 707700, enquiry@bhs.org.uk

Paths for All Partnership, Inglewood House, Tullibody Road, Alloa FK10 2HU tel. 01259 218888 info@pathsforall.org.uk

Scottish Natural Heritage Recreation and Access Group, Bonnington Bond, 2 Anderson Place, Edinburgh EH6 5NP tel. 0131 446 2061 recreationandaccess@snh.gov.uk



2. Path construction and surfacing

The basic functions of path surfacing for horses are the same as those for any other users: to facilitate travel, to protect the site and to contribute to the user's enjoyment while travelling. There are any number of surfaces, natural and man-made, suitable for and capable of withstanding equestrian use. Type of surfacing is likely to dictate the speed at which riders can travel, and can influence level of enjoyment. For cantering or galloping, hooves should be able to sink in for approximately 2.5cm beyond which there is risk of sprains or tendon damage.

Many people think of hard forest roads or disused railway lines as ideal since there is little risk of damage to the surface. From a horse-rider's perspective, although they may be "off-road" and some provide good riding, forest roads and tracks consisting of large, unconsolidated angular stone are far from fun to ride and will soon lame tender-footed horses.

Types of path construction in descending order of preference for horse-riders

- Short, firm, well-drained turf, which is ideal for riding and walking, and usually firm enough for cycling, but may not suit wheelchair users.
- Vegetated paths on firm base such as grassed over forest roads or disused railway tracks stripped of ballast to expose consolidated ash solum, which are ideal for supporting year-round multi-use, provided they are well drained.
- Paths where the natural vegetation is protected or reinforced by some type of surfacing.
- Formally constructed paths with firm, non-slip surface.
- Sealed surfaces, which may be necessary to facilitate cycle or wheelchair access, but are generally less popular with riders.

Rough, tussocky moorland is unsuitable for most horses. Well-drained grass alongside a surfaced path may provide alternative (seasonal) access for horses, but will not be popular if boggy or litter-strewn or where hidden hazards may be concealed by long vegetation. Mowing may be necessary where use is insufficient to restrict grass growth. On vehicular tracks a grass or other vegetated centre/parallel strip offers a softer, less jarring surface for riders without interfering with reinforced wheel tracks.

Road planings, brick, concrete or tarmac should all be avoided as surfacing for equestrian paths, similarly any aggregate which may set and become slippery with use.



2. Path construction and surfacing

General path construction

Formal surfacing of all equestrian paths is neither desirable nor feasible. Provided level of use is relatively low, drainage is adequate and the substrate and surface layers are sufficient to bear the weight of horse and rider, on most paths beaten earth or vegetation will be sufficient without need for artificial surfacing. Dampness is no bad thing as softer surfaces are more comfortable to ride, but there is a narrow line between

damp and wet. Wet and waterlogged paths are unpleasant for walkers, cyclists and riders, and are much more prone to damage. Basic path design considerations are summarised in “Lowland Path Construction – A Guide to Good Practice” section 2.6a, and in the Upland Pathwork manual. As with all paths, implementation by experienced contractors or volunteers who fully appreciate what is required is critical to success.

Points of particular importance on paths for equestrian use

- Weight of horses and effect of horses’ hooves must be taken into account in constructing or surfacing any paths, particularly those using cut and fill techniques.
- Holes (particularly rabbit holes), drainage grips or stone box culverts which a horse might inadvertently step into or in which a horse might get its hoof stuck are further potential hazards. The space between the sides of stone culverts should either be <100mm or >300mm.
- Brash or fascines traditionally used as floating rafts to support paths over wet ground are not usually recommended on equestrian paths because of risk of horses’ hooves slipping through surfacing to penetrate branches below leading to potential injury
- Boardwalks are not usually suitable for equestrian use unless specifically designed for multi-use including anti-slip measures.
- Free-draining sandy or chalk soils are usually able to withstand horse use without need for surfacing.
- Clay soils are particularly prone to damage by horse – frequently used paths on such soils soon become a sticky mess impassable to walkers, cyclists or riders in all but the driest weather.
- Deep peat and boggy areas in which a horse may get stuck are a riders’ worst nightmare. The first option should always be to seek an alternative route, but this is not always possible – for example where the line of historic drove roads is to be maintained. Although creating and maintaining multi-use paths in such conditions is challenging, sustainable multi-use paths across peat and bog are usually achievable with adequate resources. Options include machine laid paths (see information sheet 2.9) or paths supported on geotextiles, but given the complexities of peat depth, bearing capacity and load distribution, expert advice should be sought.



2. Path construction and surfacing

Drainage (see Section 3.1 of Lowland Path Construction Guide)

Effective drainage is the key to sustainable use of any path. The most common problem is for paths to become the line of least resistance and effectively serve as a drain or stream during heavy rainfall, leading to erosion and damage to the path surface. Drainage should be designed to deal with worst case scenarios, with pipes or ditches of sufficient capacity to accommodate maximum flow.

Paths with adjacent open ditches or drains must be wide enough to minimise risk of horses stepping or being forced off the path into the ditch/drain leading to erosion and collapse of both path and ditch. Exposed drainage and culvert pipes are a potential hazard: a combination of weight and the sharp edge of a horse-shoe will all too easily break through pipes, potentially injuring the horse and damaging the drain. All drainage pipes must therefore be covered by a suitable depth of stone to prevent crushing. Headwalls constructed to support the path over the end of drainage pipes must also be sufficiently robust to support equestrian use. Short pipe lengths and restricted path width at culvert crossings which encourage or force horses onto the edge of the path will usually lead to collapse of the headwalls. Plastic pipes used for culverts or cross drains should extend minimum 1m beyond path edges, be covered with turf or soil and/or protected by stone headwall.

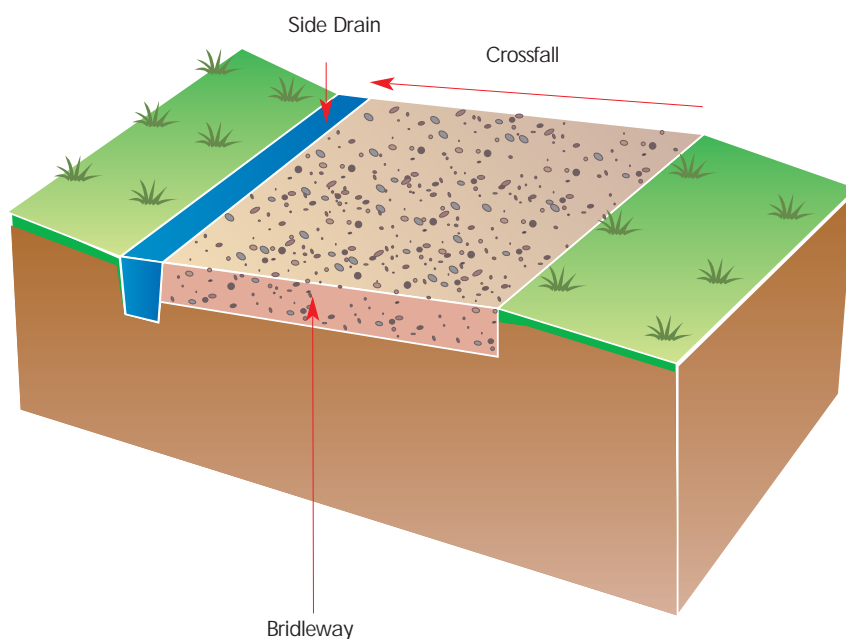



2. Path construction and surfacing

- Cross drains or water breaks to shed water off paths are likely to be required at gradients of more than 1 in 11 (i.e. > 5 degrees).
- Cross drains/water breaks should be constructed at a minimum angle of 30 degrees and maximum angle of 45 degrees to the path, with an across path slope of between 5 and 15 degrees.
- Shallow v-ditches or pitched “humps” are preferred for cross drains/water breaks. Vertical sills may restrict some path users.
- Top edge of open ditches should be 300mm minimum from the edge of the path.
- On all ditches the sides should be angled so that the surface width is at least twice the width of the base (minimum width 300mm, minimum depth 300mm).
- French drains - where a perforated drainage pipe is laid in the bottom of a ditch backfilled with stone - can be smaller than open ditches, but they do not allow the option for regular cleaning or re-excavation. French drains should be kept to the side of paths and covered in minimum depth 250mm clean stone (300mm minimum for cross drains).



Boggy paths present real problems: a walker may simply get wet feet, but a horse can sink because of the added weight, with potentially fatal consequences.



2. Path construction and surfacing

Surfacing

Assessment of surfacing options should take account of existing and potential level and type of use by walkers, cyclists, and riders of all ages and abilities. Material used for path surfacing should be non-slip, resilient and require minimal maintenance.

Grass paths should always be the first choice for equestrian use, but sustainability depends on drainage and soil type. Regular use will help maintain a short sward suitable for all users, and provided trampling from use does not exceed plant growth, virtually no maintenance will be required. Where use is high and vegetation is unable to keep up with damage resulting in deterioration of the sward, artificial surfacing may be required. Specifications for the two most common types of surfaced or artificially constructed path suitable for horses are provided below. Where considerable depth of sub-base is required, coarser stone material can be laid at the lowest level, grade and type depending on what is available locally. Lake District National Park Authority have had great success using crushed slate as the sub-base for resurfacing a disused railway line to provide all-abilities multi-use access.

- Woodchips are very popular with riders but are unsuitable for wheelchairs and cyclists. Woodchips are difficult to contain to the path and rot, requiring regular removal and/or replacement. As such woodchips are not recommended.
- Sand is also popular with riders, provided it is not too deep (recommended 75mm on 150mm depth of free-draining sub-base) and relatively coarse grained, but it is usually difficult to contain on a path and is not suitable for wheelchairs or cyclists.
- Consolidation of most surfacing material is essential for compaction. Machine tracking across the graded surface may be adequate, or vibrating rollers may be used on drier ground.
- Most newly created paths with unbound surfacing will need a minimum 3 months to allow surface settlement before supporting multi-use. Effective signage and enlisting the support of riders and cyclists to avoid use are essential during surface consolidation.

Grassed gravel paths

Grassed gravel paths offer a hard, green surface which is often ideal for multi-use. The specification for aggregate paths outlined below is replaced by 200mm minimum total depth of ungraded gravel mixed with 15mm of topsoil in top 100mm, seeded with a wear resistant grass species.



2. Path construction and surfacing

Example specification for unbound aggregate path

(See also Information Sheet 3.6 Lowland Path Construction Guide)

Typical aggregate path construction

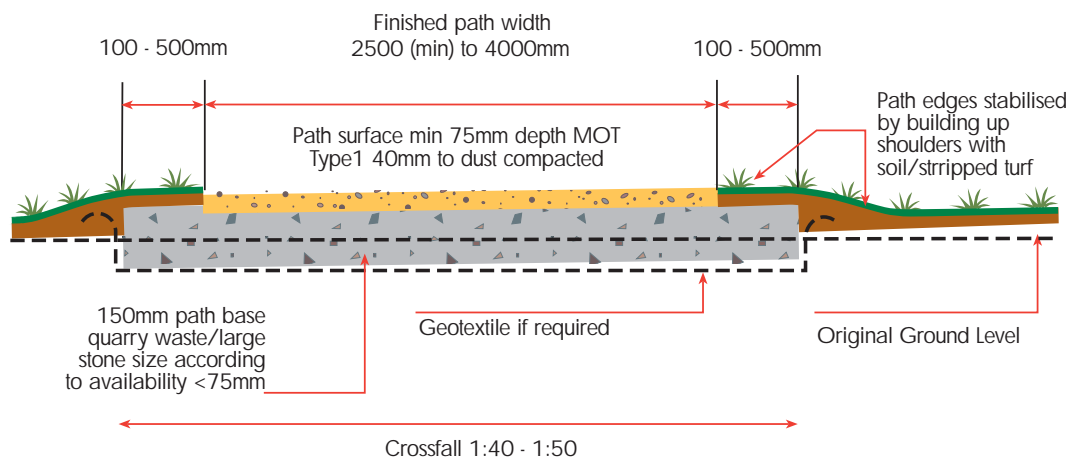

- Finished surface of bridleway should be above level of adjacent ground to allow water to drain freely.
- Crossfall should be in the range of 1:30 to 1:50
- On paths with wheelchair access, camber with profile in range 1:25 to 1:50 should be used in preference to cross-fall
- Surfaced paths should be finished with compacted 40mm to dust (Type 1) crushed stone blinded with fines (10mm to dust) or whin dust to fill voids, bind and smooth the surface.
- On some sites adequate paths may be created by laying Type 1 only without coarser base material (where necessary supported by a geotextile), but compaction of the surface prior to use by roller is likely to be essential.

Geotextiles

Geotextile and other artificial membranes (particularly geogrids) may be essential on some shared used paths, but can present problems for horses where material exposed by path erosion may catch on hooves. Where geotextile is essential for path reinforcement or layer separation, it should be buried to minimum 225mm depth with aggregate or turf. Particular care should be taken to ensure that the geotextile does not rise to the surface or become exposed at path edges. On soft ground such as peat or clay, geotextile is more likely to move and stretch when subjected to horses' weight. Either use a fabric with greater strength to resist tearing, or a plastic grid reinforcing membrane (geogrid) such as Tensar.



2. Path construction and surfacing

Seeding of surfaced paths

To help stabilise newly formed paths and encourage naturalisation, seeding is recommended immediately on completion before the path surface has chance to dry out (otherwise the seed is too easily washed or blown away). Seed mix should take account of site location, altitude, exposure, soil type and fertility, future level of use and nature conservation considerations. Preference is for a mixture with a high percentage perennial rye grass and sheeps/chewings fescues to act as a nurse crop allowing slower growing native grass species to establish. Local seed merchants will advise on suitable mixtures and sowing rates. Seek advice from Scottish Natural Heritage area officers in respect of any paths through or near Sites of Special Scientific Interest or of known nature conservation interest.

Views vary on the advantages of applying fertiliser, usually in mixture with the grass seed. Pennine Bridleway staff are experimenting with Rigby Taylor Planting Plus with a composition of 5:18:10 (nitrogen:phosphate:potassium) at 35g/square metre.

Stone pitched and flag paths

Stone pitching is not ideal for horses but may be necessary to provide a firm entry/exit to a ford, and may be the only option on some heavily used mountain paths. Smaller random (rather than dressed) stones laid to provide a slightly irregular finished surface will allow more grip than large, flat stone faces, but only if the horse's hoof can be placed flat on the ground. Stones should be pitched vertically with the longest face into the slope. Adjoining stones should be pitched to provide a foothold of minimum 300mm width. Downhill gradient of foothold should be <5 degrees. Stone which may become polished and slippery through wear should be avoided.

Stone flag paths favoured on some remote multi-use routes such as the Pennine Way high on the Cheviots can be dangerous for horses if they step off the flags. Where there is no practical alternative but to use flags on equestrian paths, wider flagged or hard surfaced areas should be provided at regular intervals to allow walkers and riders to safely pass each other, or if necessary to turn around. Users should be able to see before setting foot on the flags whether the next section of the path is clear.

Steps

Horses can cope with steps, particularly if there is room to allow all four feet to stand together between risers, but wherever possible an alternative should be found, such as a graded ramp which is easier for riders to negotiate. Where steps are the only option:

- riser height should be minimum 150mm, maximum 250mm
- depth of tread (i.e. distance from front to back of step) should be minimum 2m

Detailed specifications are included in the Countryside Access Design Guide section 4. Maintenance is essential to ensure safety for all users.



2. Path construction and surfacing

Improving Existing Paths

By far the majority of paths to be used by horses are pre-existing tracks or paths where provided the drainage is acceptable, there may already be a potentially suitable base but the surface requires amelioration.

On softer paths, it may be sufficient to remedy any drainage problems, scrape off accumulated mud and dress the path with suitable surfacing, such as 100-200mm depth of compacted MOT type 1 stone (40mm-dust). Need for finishing with whindust will depend on individual location, resources and future use.

Hard forest roads, disused railway tracks with exposed ballast and other tracks with hard, sharp stone surfaces may be improved for horses by surfacing with 75-100mm depth compacted MOT type 1 (40mm-dust) dressed with whindust to fill the gaps (interstices) between the larger stones.



Sharp, stony surfaces such as hard forest roads are rarely favoured by horse-riders but once grassed over are ideal for walking cycling and riding.

Obviously there is little point spending money on re-surfacing forest roads which are likely to be used in the near future as extraction routes, where new surfacing would be damaged by the volume and weight of traffic. Many forest roads and other similar hard, stony tracks improve over time from a horses' perspective because of the consolidating effect of extraction lorries and other traffic, and because accumulated mud and earth fills the gaps between stones and blunts sharp edges. Depending on availability of suitable material, there is potential to improve stony tracks for equestrian use by mimicking this process, in other words dressing the surface with soil and compacting the soil into the surface. Subsoil is as effective as topsoil, but may take longer to re-vegetate. Soils with a high clay content are less suitable, whereas sandy soils are ideal, provided the sand does not migrate off the track or percolate through the track too far below the surface.



Remedying drainage problems is often all that is required to restore existing paths for multi-use access.



2. Path construction and surfacing

As dug or machine built paths using soil reversal technique

As dug or machine built paths (also known as hymax laid paths or soil reversal technique) as outlined in sheet 3.6 of the Lowland Path Construction Guide have proved very successful on equestrian routes around the country, including the Pennine Bridleway and drove roads in the south of Scotland. In view of the relevance of this technique to equestrian access, and shortage of information elsewhere, further details are summarised below. These will need to be modified to suit individual site conditions.

The technique is so called because substrate excavated by machine on site (either adjacent to the path or from local borrow pits) is used to form the path. This can therefore be a cost effective option where the costs or conservation implications of importing material are prohibitive. However suitability of the technique depends on type and depth of substrate.

Hand or machine dug test pits are advisable to check suitability of material. The ideal is for stone/shale/gravel sub-base finished with a consolidated mixture of finer stoney material bound together with particles of soil. Sand is unlikely to be suitable unless mixed with stone due to risk of mobility. Where stone content of substrate is low, it may be

necessary to dress the path with material excavated from local borrow pits. Where the stone content of substrate is high, larger stones should be placed at the bottom of the constructed path. Where all stone excavated is too large, it may be necessary to crush the stone, remove larger stones and/or mix/dress with smaller stone/soil. If suitable substrate cannot be found within 3.66m, then alternative options usually need to be considered.

Experience has clearly demonstrated that use of a skilled contractor with a proven track record of successfully implementing this technique, working to a detailed specification, is critical to long-term sustainability of the path. The size and weight of machine used requires careful consideration, taking account of potential damage and landscape impact. On peat it may be necessary to excavate to 3m – 6m depth, which usually requires a 13.5 t machine. Finished path width of 2m is adequate to support horse-riding, cycling and walking, but it should be borne in mind that a 13.5t machine will require minimum 3m width to back-track along the finished path. Section 1.7 of the Upland pathwork guide offers further advice on use of mechanised equipment.



2. Path construction and surfacing

Before



During



A 13.5ft machine is usually necessary to excavate to sufficient depth to reach suitable substrate for surfacing

After



After





2. Path construction and surfacing

Machine laid (hymac) path

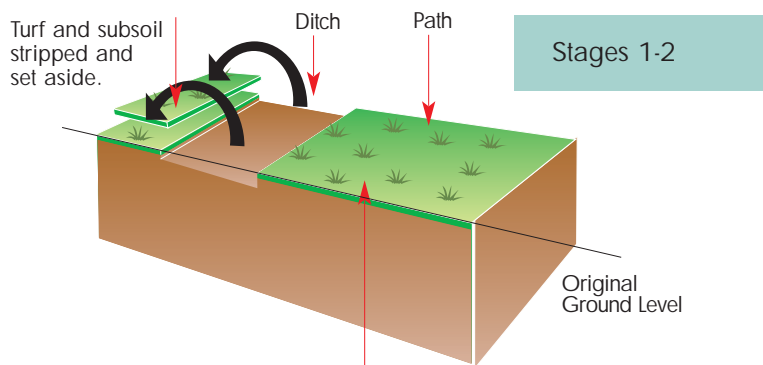

On peaty soils, leave vegetation/surface of proposed path undisturbed. On non-peaty soils, remove turf and set aside to reveal sub-soil. Excavate sub-soil and set aside.

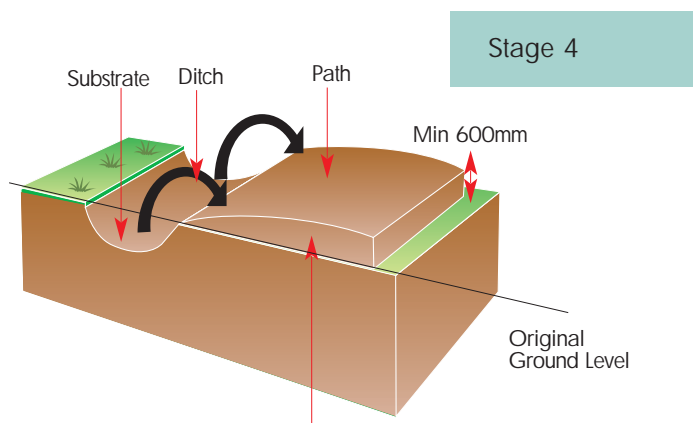

Path formed from substrate excavated from ditch, with coarsest stone at base of path.

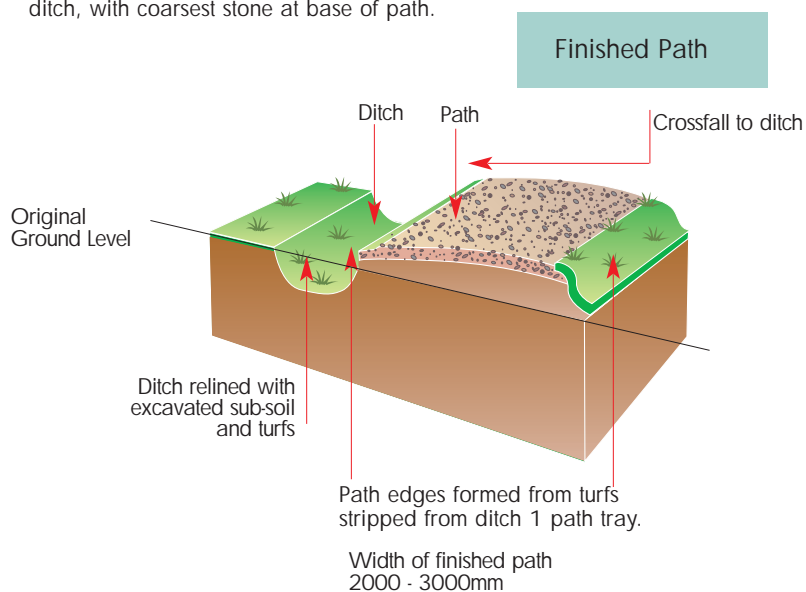



2. Path construction and surfacing

Method

1. On non-peaty soils, facing in the direction of advancing work, remove turf from the line of the proposed path by using machine bucket to cut and tear large undamaged blocks of topsoil and attached flora. Turning excavator through 180 degrees, set aside the turf clear of the path. Remove revealed organic matter/subsoil from the path line to provide a sound foundation. On peaty soils, leave surface of proposed path undisturbed so that entire path will be formed above the original ground level.
2. Excavate ditch upslope of proposed path to depth of substrata, setting aside excavated turves and organic matter.
3. Install minimum 300mm diameter twin-walled plastic drainage pipe to culvert water from ditches on uphill side under the path.
4. Excavate substrate and deposit onto route of path to min. depth 600mm (on peaty soils this will mean depositing excavated substrate onto undisturbed mat of vegetation; on non-peaty soils excavated substrate will be deposited onto path bed as detailed in 1 above).
5. When sufficient material has been deposited to bring the path to the required level, camber the path to shed water into the ditch. Compact the surface with back of excavator bucket.
6. Where path surface created from excavated material is inadequate, an additional ditch may be required on the downhill side.
7. Replace excavated subsoil into ditch and relay excavated turves on top. Finished ditches must have a smooth base formed on a grade to prevent stagnation and must be profiled to a smooth cross section as a base to improve re-establishment for reinstated turves.
8. Depending on timing of work, simply allowing the path to settle over winter may be sufficient, but on other paths it may be necessary to compact the surface of the finished path with a roller or vibrating plate to avoid damage by horses' hooves before the surface has consolidated.
9. Seed newly created path with suitable mix of native grass species.



3. Gates

Guidance on siting and selection of access structures is included in Section 1 of the “Countryside Access Design Guide”, with specifications for horse stiles and gates in sections 2 and 3. Ease of negotiation of gates and other boundary controls is arguably even more significant on horseback than on foot or cycle, due to the need to control the horse at the same time as opening and closing a gate. As on all paths, the priority should be adopting the least restrictive option, with gates or other structures installed only where a gap in a boundary is inappropriate for whatever reason.

Horse-riders do not expect, nor can they demand, that every gate is negotiable without dismounting, but getting on and off to open and close a long string of gates across a path is a major detraction from the enjoyment of riding. Mounting and dismounting can be difficult, and in some cases dangerous, where there are other livestock in the field which one is entering or exiting, particularly playful bullocks or defensive sucklers and their calves, as on many existing paths.

Ensuring gates are horse-friendly requires those responsible for installation and maintenance to understand how riders attempt to negotiate a gate. A rider will approach the latch or fastening of a gate with the horse alongside and parallel to the gate (i.e. “heels to hinges”). The key is to ensure adequate room beyond the shutting post for the horse’s head to extend whilst remaining parallel to the gate. Gates positioned with the fastening in the very corner of a field can prove problematic where the horse cannot stand with its head and neck beyond the gate so that the rider is beside the latch. The only options are then for the horse to face the gate at right angles, with its head over the gate the rider is trying to open, or for the rider to dismount. Remnant posts, overgrown hedges, broken culverts, large stones or other obstructions in the vicinity of the opening mechanism also make it impossible to open a gate whilst mounted.

As well as ensuring the rider is able to position their horse correctly in relation to the gate, the catch or fastening mechanism must also be easy to reach and readily operable from horseback.

Key considerations re. gates for horse use

- Internal width between gateposts or other structures to allow equestrian use should be 1.52m (minimum 1.2m), with greater width before/after point of entry.
- Riders can only close gates, mounted or dismounted, if there is sufficient space to turn the horse. Horses need a minimum 2.9m turning space.
- Gates should be sited on level ground. Where necessary, a level platform of minimum dimension 3m x 3m should be created to allow riders to negotiate the gate safely.
- Gates leading onto or off a road should be set a minimum 5m back from the road to allow the horse to be clear of the carriageway while negotiating the gate.



- Gates should be equally easy to open and close from either side.
- Gates should swing freely on hinges, and be capable of being opened and closed without lifting, preferably without dismounting.
- Gateways should be well drained to facilitate access by all users, mounted or otherwise.
- Stops to prevent gates swinging back too wide are invaluable for riders (and most other users).
- Two-way opening gates are much easier for horse-riders, and others, to use than one-way gates.
- One-way gates are usually recommended at path/road junctions, opening away from the road, although if the gate is set sufficiently back from the path a two-way gate may still be feasible.
- Trailing bars under gates frighten most horses.
- Nails, barbed wire and other sharp protrusions on which a horse or rider might catch themselves should be removed.
- Large boulders or tree trunks are useful deterrents to restrict illegal vehicular access where no formal barrier is required, but should be carefully sited to avoid restriction of access by legitimate users.
- Electric fencing adjacent to gates is a potential hazard in that horses accidentally touching the wire are likely to get an electric shock which may cause them to rear or bolt. Electrified wire should therefore be dropped (double insulated galvanised wire in a flexible plastic pipe) and run in a trench min. 400mm below surface, or sheathed for a minimum 1m (preferably 2m) back either side of gateways to prevent horses accidentally electrocuting themselves, which can lead to accidents.

Gateway in electrified fence

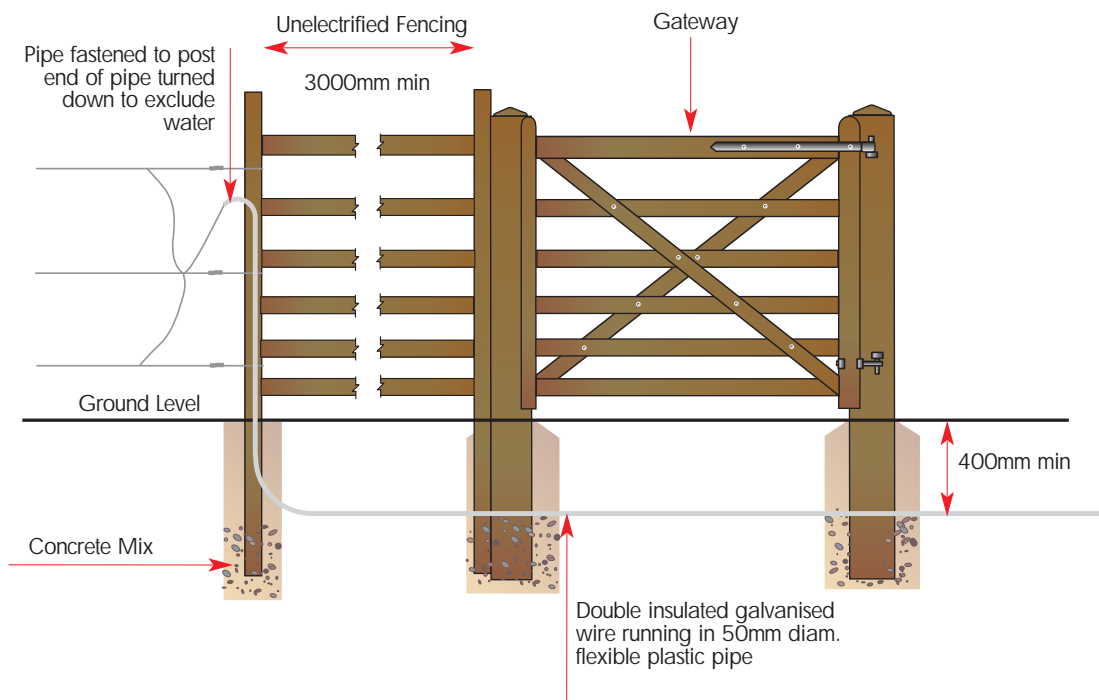



3. Gates

A range of gate designs are available from local and national suppliers. Use of metal or timber gates is a matter of personal choice, and will also depend on location, resources and aesthetic considerations. Metal gates are usually more durable and less prone to vandalism but can look rather urban in a rural setting.

Self-closing bridlegates have proved highly successful in a range of circumstances, being readily accessible not only to riders, but also to walkers, cyclists, wheelchair and buggy users, and offering reassurance to farmers about gates inadvertently being left open. The gates are fabricated from galvanised steel and steel mesh, and supplied complete with an integral 'H' frame which ensures that the latch and gate are kept permanently aligned, reducing maintenance requirement. With practice horses soon get used to self-closing mechanisms, but fitting of springs or weights which cause the gate to close too rapidly should be avoided. Off-set hinges with an adjustable bottom fitting are ideal. Posts should not be used as strainers for fencing.

Self-closing two-way opening metal bridlegate

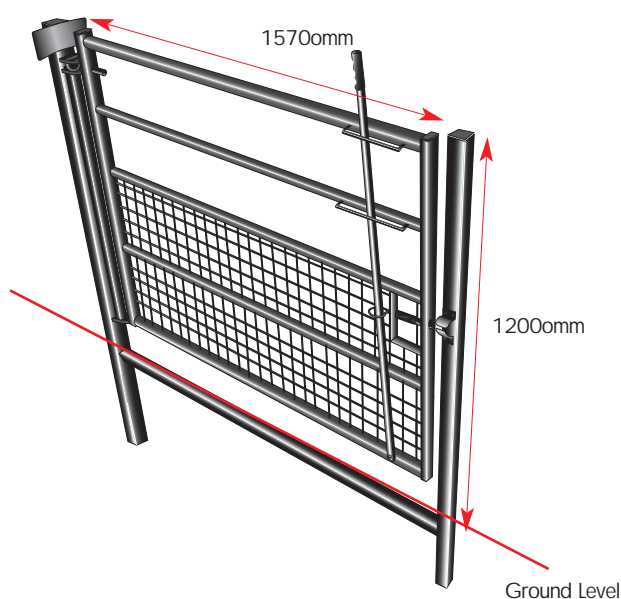

Where necessary bridlegates can be installed adjacent to a field gate which the farmer can choose to secure open or closed. Where both a bridlegate and full-width field gate are required but there is insufficient space for both, a two-in-one gate may be appropriate.

York two-in-one gate

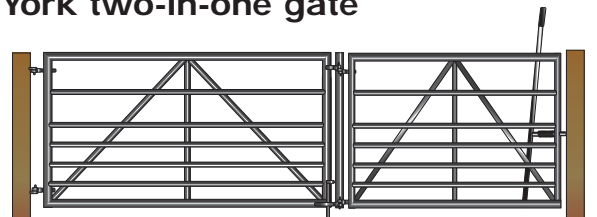

The complete gate can either be opened as one unit, or there is option to lock the main gate with a heavy duty drop bolt to prevent unwanted vehicular access while the section allowing equestrian and other public access remains free to open.

At present the sole supplier of these gates is Centrewire Ltd. (PO Box 11, Wymondham, Norfolk NR18 0XD tel. 01491 614490).

Where wooden gates are preferred or delivery costs for a small number of gates are disproportionately high, standard gates purchased from local suppliers can be made more horse-rider friendly by attachment of suitable fastening mechanisms.



3. Gates

Gate catches and fastening mechanisms

Ideally catches should be operable with one hand and riders should be able to reach gate fastenings from the saddle without dismounting. Trigger or spring-loaded bolt type fastenings can be dangerous as horses and/or riders can easily catch themselves on the metalwork, similarly hunter latches or extended handles. Throw-over chains are easy for riders to open but are not cattle-proof. Many farmers favour chains which have to be wrapped around a gate or posts, but these are notoriously difficult for horse-riders or other users, and consequently are not always securely closed. Clasps and other gate fastenings should be attached towards the top of the gate within riders' reach without dismounting but still within easy reach of pedestrians or wheelchair users.

Tips on gate catches and fastenings

- Easy-latch (available from Centrewire, address as above) or similar gate fastenings are the most horse-rider friendly, and are also much easier for walkers, cyclists and wheel chair users to operate than standard gate fastenings.
- Many farmers are initially sceptical about bridlecatches, but the stockproof handles which have to be lifted at the same time as the handle is pulled to one side have proved infallible to cattle whilst still easily negotiated by riders, walkers and cyclists of all abilities.
- "Trombone" handles give better access to all users from both sides than easy-latches but are not stockproof.

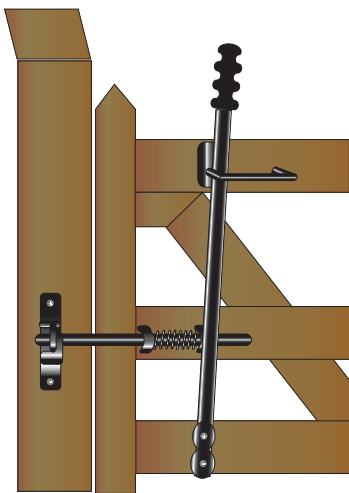

Easy-latch

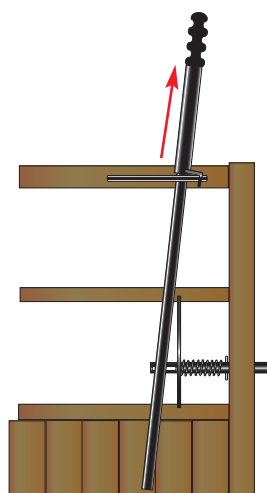

Stock proof handle

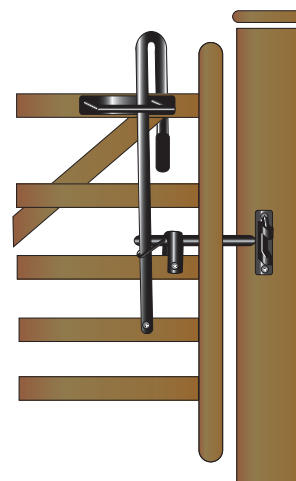

Trombone handle

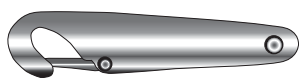

Safety gate hook

Simple hook and eye fastenings are available from most agricultural and fencing suppliers. Heavy duty safety gate hooks and eyes may also be bought locally. In case of difficulty sourcing contact manufacturers: Eliza Tinsley, Reddale Road, Cradley Heath, West Midlands B64 5JF tel. 01384 566066.



3. Gates

Gates next to cattle grids

Some horses cannot be persuaded to stand facing cattle grids because they sense the potential danger of stepping into the grid. Gates provided to by-pass cattle grids should therefore be sited so that the horse is not required to face the grid while the catch is being operated. Catches on gates next to cattle grids should be at the end furthest from the grid, with the hinge nearest the cattle grid. A fence should be erected beside the cattle grid to prevent startled horses accidentally stepping into the grid whilst opening the gate.

Horse stiles and motorcycle barriers

Horse stiles can help deter illegal motorcycle use on equestrian or multi-use paths as motorcycles must be lifted over the barrier to gain access. However, horse stiles should only be installed where there is a proven and demonstrable need to deter access by motorcyclists as this type of barrier can present an obstacle to some users. Access for other users, including wheelchairs, should be provided adjacent to the horse stile. Riders may need to be encouraged to train their horses to become confident in using such barriers.

Several different versions of horse stiles are included in the 'Countryside Access Design

Guide' section 1, the most popular of which are outlined below. A clear manoeuvring space 4m high, 3m long and at least 2m wide should be provided immediately before and after horse stiles to allow horses to walk straight through the structure – no gates should need to be opened whilst walking through. Horse stiles should always be set back minimum 5m from the road in case horses unexpectedly attempt to jump the barrier.

Single or parallel wooden sleeper "motorcycle trap" constructions intended to catch the sump of motorcycles are used throughout Britain.

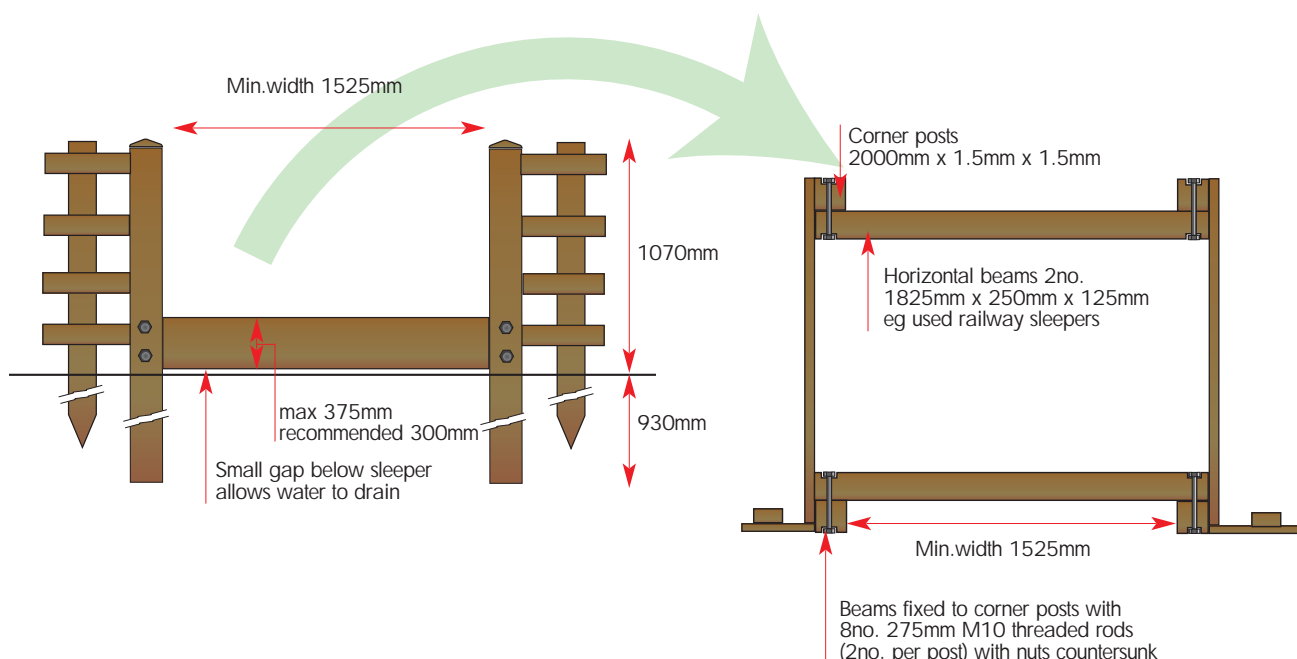



3. Gates

- Gap between beams should be surfaced with aggregate sub-base or other suitable material to prevent muddy puddles developing which may restrict access.
- Holes for corner posts should be dug as narrow as possible and filled either with well rammed earth and stones or concrete.

Step-over horse stiles have proved very successful on the Formatine and Buchan Way, allowing access by horseriders and cyclists without dismounting. This type of stile is preferred by some riders because there is only a single beam to negotiate, but may be less effective against motorcycles, especially lighter trail bikes.

Step over horse stile

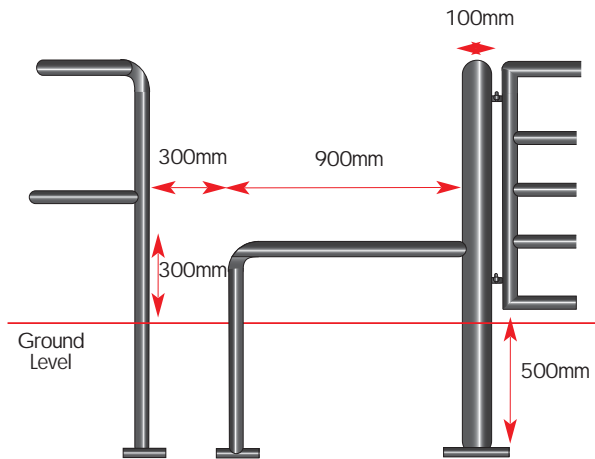

Double stockproof gates/pens

Where farmers are particularly concerned about risk of livestock escaping, for example on a march boundary with forest or open moorland, a double gate arrangement or pound may be necessary where the first gate must be closed before the second gate can be opened. Positioning of gates is critical to ensure that riders still have sufficient space to turn to operate the gates.

Double stockproof box gate/pen

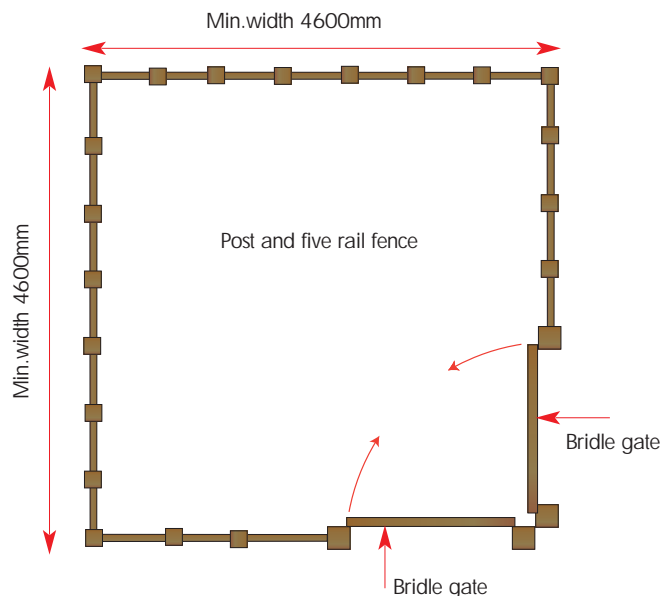

Mounting blocks

Where riders are likely to be mounting their horses, for example near gates which cannot be opened from horseback, opportunity to position the horse downhill of a bank or natural slope can be a considerable advantage in reducing the height differential between rider and saddle. Where there are no such natural features, a large stable stone or tree trunk may be adequate. In some situations, it may be worthwhile constructing specific mounting blocks, particularly to help less able riders. Recommended dimensions are minimum 450mm wide by 650mm high, with step at 350mm.



4. Bridges, water and road crossings

Fords

Fords are usually cheaper than bridges and preferable where maximum depth of watercourse is <0.5m in normal conditions, offering simultaneous opportunity for horses to drink.

- Fords must have firm, low gradient (< 1 in 10) entry/exit and a firm, level base within the watercourse. Depth poles and markers for entry/exit points should be provided where the ford is wider than 4m. Stone pitching may be necessary in some situations to protect entry and exit from fluctuating water levels and potential damage from equestrian use.
- Alternative routes/crossings should be signed for times of flood or horses and riders averse to water.

Bridges

Bridges must be sufficiently robust to withstand weight of horse and rider (average 500-600kg) without sway and preferably without undue noise or echo. Cross-struts can help stability. Drops from bridges or paths look far more daunting viewed from a horse than from the ground.

Underpasses

Underpasses are preferable to bridges for crossing busy roads, minimum height 3.7m, recommended minimum width 3m. Gates at either end of the underpass may be necessary for stockproofing, but wherever possible should be set well back from the underpass in case horses panic at the sound of overhead traffic.

Key considerations re. horse bridges

- Minimum recommended width of bridges for equestrian use 1.5m (up to 3m span) and preferably minimum 2m width for spans up to 8m. For wider river/road crossings, minimum width 4m recommended.
- Sleeper bridges may be suitable for spans <3m but should still be 1.5m minimum width (preferably 2m). Maximum 10mm gap between individual sleepers.
- Kicking boards should be provided on all bridges to infill from decking to a height of at least 250mm to prevent risk of hooves slipping between rail and decking. Minimum 0.6m on bridges over main roads, with remainder to handrail height filled with mesh. A gap of <50mm between the kick board and decking will facilitate drainage and allow accumulated leaves or other debris to wash off.
- Parapets are recommended on bridges where drop is >1m.
- Recommended height for handrails on bridges used by horses 1.8m, although in practice 1.5m may be acceptable depending on drop below bridge.
- Horses are easily frightened by sight of water/traffic below bridges, hence maximum gaps between decking planks should be <10mm.
- Surface/decking should be rendered non-slip by treating with epoxy resin and bauxite grit. Wire netting is easily torn by horse-shoes and is therefore unsuitable for equestrian use.
- Gates leading onto/off bridges should allow a minimum 2.9m turning space to allow riders to close the gate behind them.
- Fenced "wings" may be necessary at the end(s) of bridges to prevent risk of horses shying off abutments. Protruding ends of fencing rails are a potential hazard on which a rider could catch stirrups or reins, and should therefore be finished with a vertical post cut flush with the top rail.



Cross Section

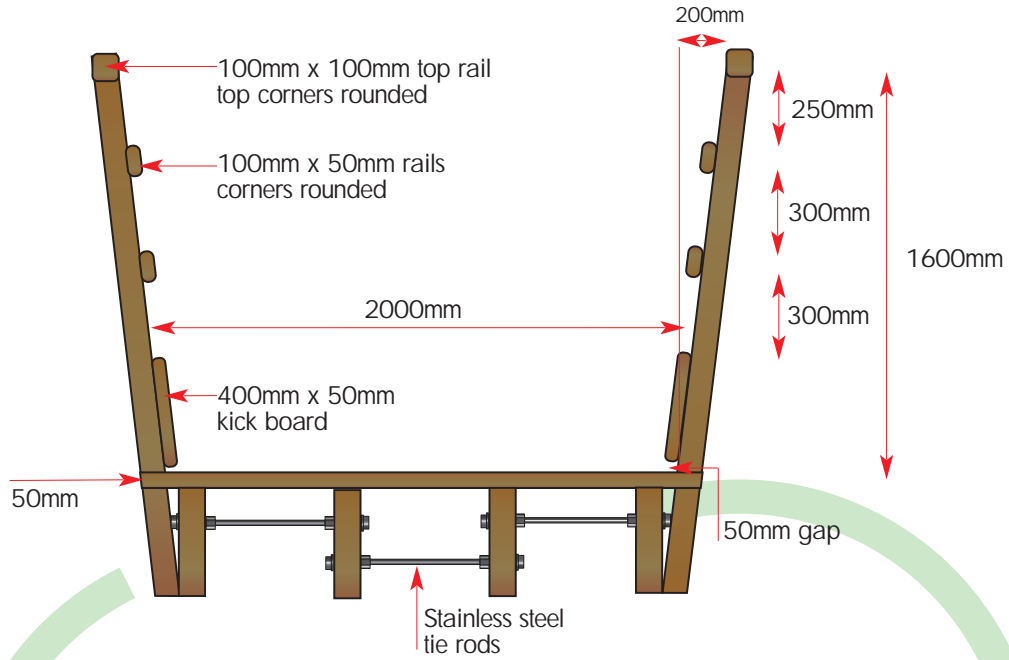

Timber Deck Plank Detail

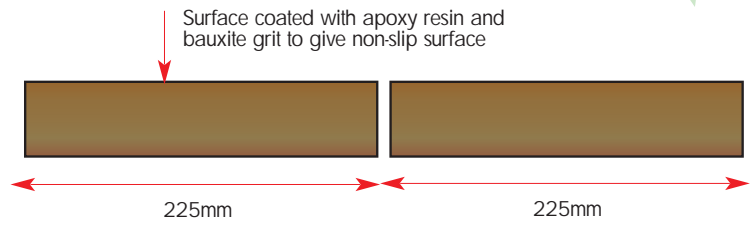

Elevation

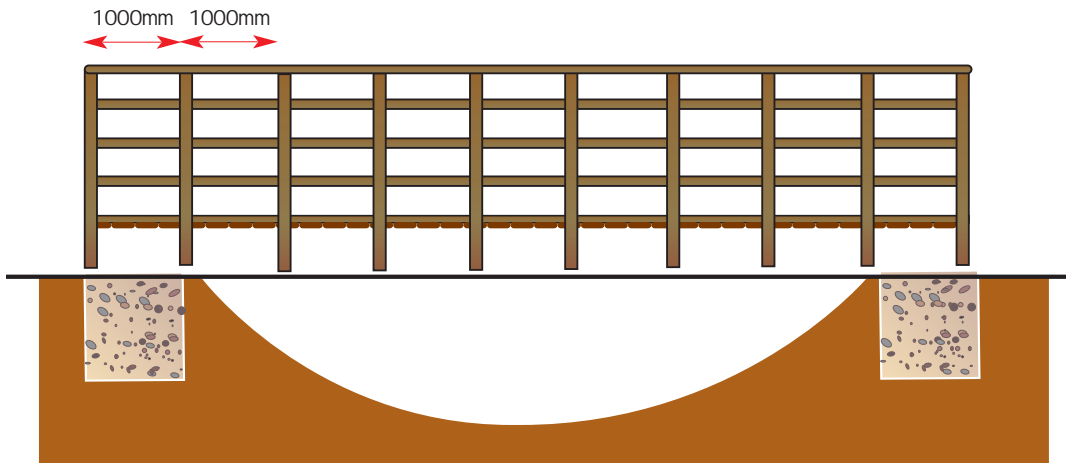



4. Bridges, water and road crossings

Simple Sleeper Bridge suitable for horses

